

# Bloques T

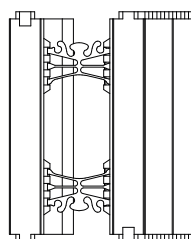

AN. DEL NÚCLEO	150mm	200mm
LONGITUD A	1321mm	1372mm
ÁREA/UNIDAD*	1.115m <sup>2</sup>	1.161m <sup>2</sup>
CANTIDAD/JUEGO	2 Bloques T + 2 Bloques T Longo	
CÓDIGO JUEGO #	NUS-10T06-06	NUS-10T08-08
*Una unidad representa un bloque en T y un bloque en T Longo, que conectados, forman dos trazos, como se ilustra en la imagen 1.		

imagen 1

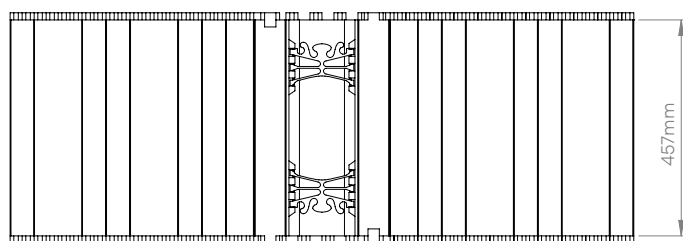
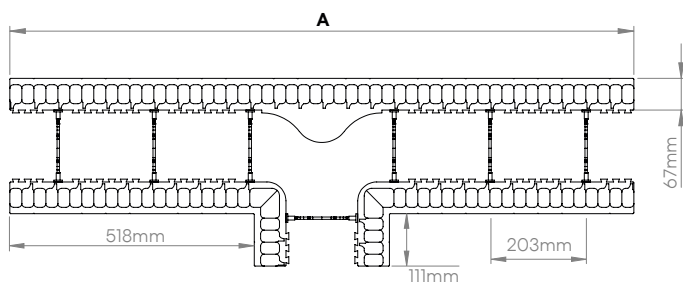
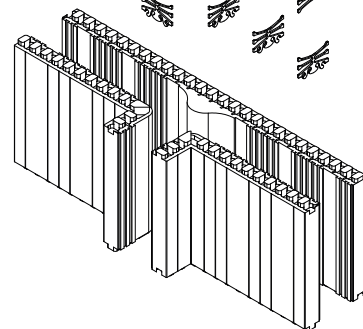
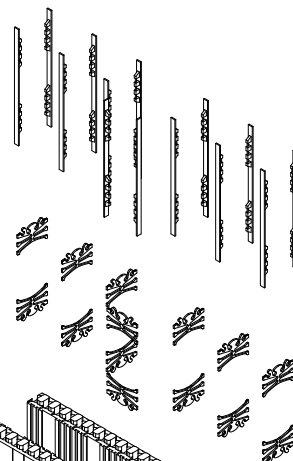
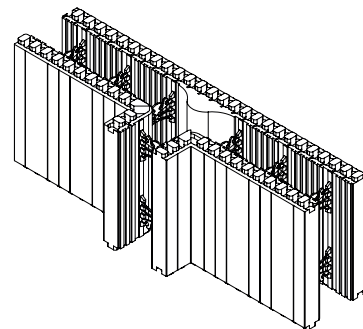
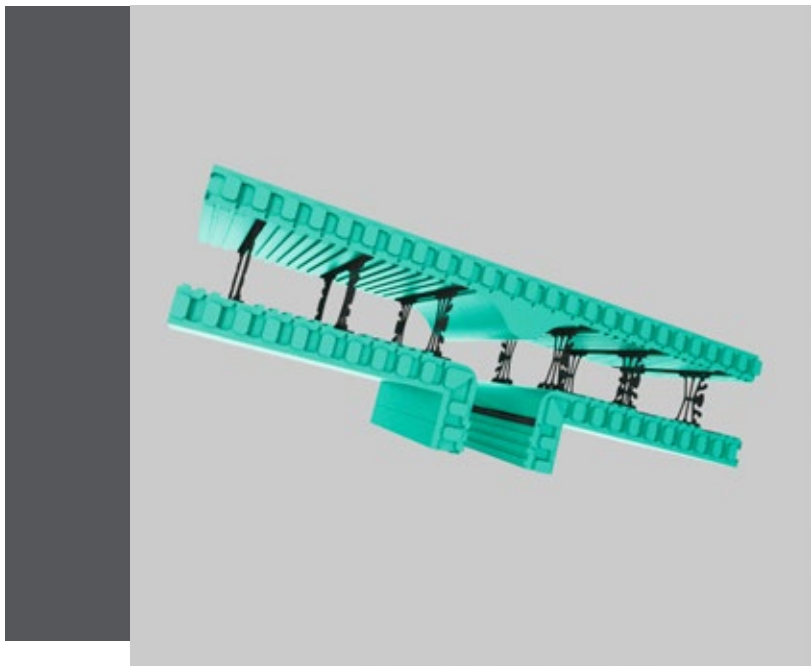