

Short T-Form Unit

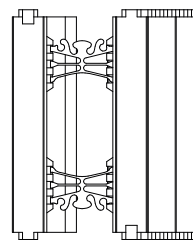

CORE WIDTH	6" (150mm)	8" (200mm)
LENGHT A	52" (1321mm)	54" (1372mm)
AREA/UNIT*	12 ft ² (1.115m ²)	12 1/2 ft ² (1.161m ²)
QTY./BUNDLE	2 Short T-Forms + 2 Long T-Forms	
BUNDLE CODE #	NUS-10T06-06	NUS-10T08-08
*One Unit represents one Short T-Form and one Long T-Form connected together, forming two courses, as illustrated in image 1.		

image 1

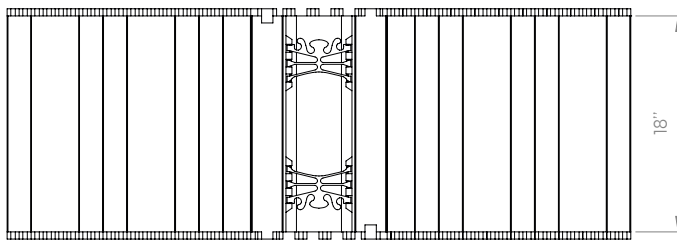
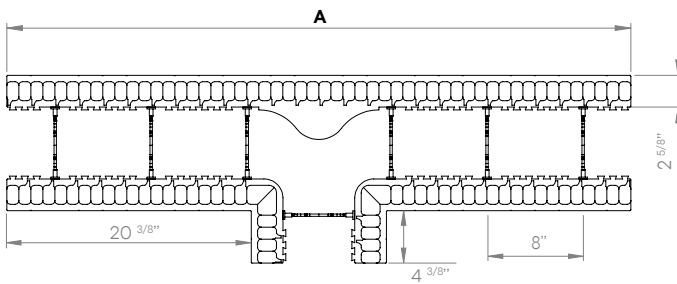
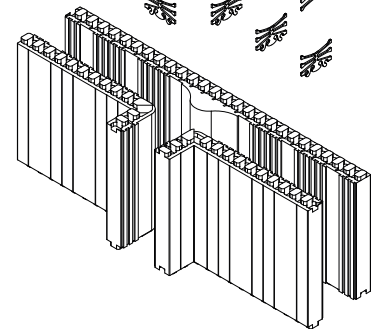
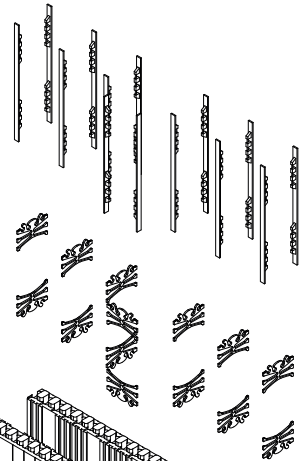
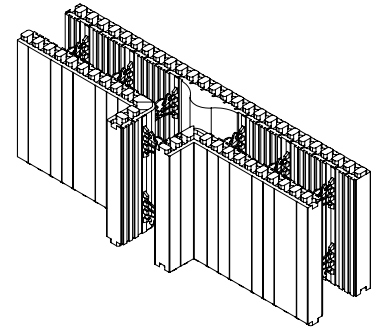
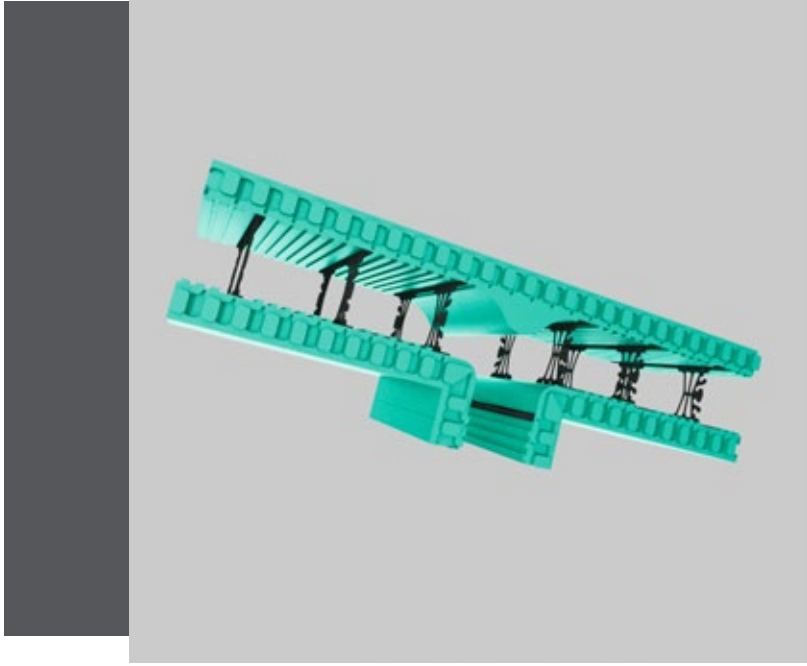